

IRON HEART

IRT-PULSE

USER MANUAL



British Engineering from the
Black Country United Kingdom



www.laney.co.uk

Welcome

Dear Player,

Thank you very much for purchasing your new Laney product and becoming part of the worldwide Laney family. Each and every Laney unit is designed and built with the utmost attention to care and detail, so I trust yours will give you many years of enjoyment.

Laney products have a heritage which stretches back to 1967 when I first began building valve amplifiers in my parents' garage.

Since then we have moved on from strength to strength developing an extensive range of guitar, bass, public address, multi instrument and keyboard amplification products along with a list of Laney endorsees that includes some of the world's most famous and respected musicians.

At the same time we believe we have not lost sight of the reason Laney was founded in the first place - a dedication to building great sounding amplification for working musicians.

Warm Regards,



Lyndon Laney Chairman & Founder

Forged deep within the Black Country – the metal beating industrial heartland of the UK – where the sound of metal music was born, comes the IRT-PULSE.

Designed to give you true Ironheart performance in a convenient desktop package, either directly into your DAW using the T-USB 2.0 interface, as a silent practise aid or in front of your amplifier as a high-end boost pedal, the IRT-PULSE adds a heartbeat to any application.

The IRT-PULSE features a pair of high voltage 12AX7 tubes, switchable on-board cabinet emulation, leadless RE-AMPING, plus an AUX in and a stereo headphone socket on-board, plus a host of other features in the most compact IRONHEART to date.

Add an IRT-PULSE to your set up – whatever it is.





Important Safety Instructions

WARNING: When using electrical products, basic cautions should always be followed, including the following:

1. Read these instructions.
2. Keep these instructions safe.
3. Heed all warnings.
4. Follow all instructions.
5. Do not use this apparatus near water.
6. Clean only with a dry cloth.
7. Do not block any of the ventilation openings. Install in accordance with manufacturer's instructions.
8. Do not install near any heat sources such as radiators, heat registers, stoves or other apparatus (including amplifiers) that produce heat.
9. An apparatus with Class I construction shall be connected to a mains socket outlet with a protective connection. Do not defeat the safety purpose of the polarized or grounding-type plug. A polarized plug has two blades with one wider than the other. A grounding type plug has two blades and a third grounding prong. The wide blade or third prong is provided for your safety. If the provided plug does not fit into your outlet, consult an electrician for replacement of the obsolete outlet.
10. Protect the power cord from being walked on or pinched, particularly at plugs, convenience receptacles, and the point they exit from the apparatus.
11. Only use attachments/accessories provided by the manufacturer.
12. Use only with a cart, stand, tripod, bracket, or table specified by the manufacturer, or sold with the apparatus. When a cart is used, use caution when moving the cart/apparatus combination to avoid injury from tip-over.
13. The mains plug or appliance coupler is used as the disconnect device and shall remain readily operable. The user should allow easy access to any mains plug, mains coupler and mains switch used in conjunction with this unit thus making it readily operable. Unplug this apparatus during lightning storms or when unused for long periods of time.
14. Refer all servicing to qualified service personnel. Servicing is required when the apparatus has been damaged in any way, such as when power-supply cord or plug is damaged, liquid has been spilled or objects have fallen into the apparatus, the apparatus has been exposed to rain or moisture, does not operate normally, or has been dropped.
15. Never break off the ground pin. Connect only to a power supply of the type marked on the unit adjacent to the power supply cord.
16. If this product is to be mounted in an equipment rack, rear support should be provided.
17. Note for UK only: If the colours of the wires in the mains lead of this unit do not correspond with the terminals in your plug, proceed as follows:
 - a) The wire that is coloured green and yellow must be connected to the terminal that is marked by the letter E, the earth symbol, coloured green or coloured green and yellow.
 - b) The wire that is coloured blue must be connected to the terminal that is marked with the letter N or the colour black.
 - c) The wire that is coloured brown must be connected to the terminal that is marked with the letter L or the colour red.
18. This electrical apparatus should not be exposed to dripping or splashing and care should be taken not to place objects containing liquids, such as vases, upon the apparatus.
19. Exposure to extremely high noise levels may cause a permanent hearing loss. Individuals vary considerably in susceptibility to noise-induced hearing loss, but nearly everyone will lose some hearing if exposed to sufficiently intense noise for a sufficient time.

The U.S. Government's Occupational Safety and Health Administration (OSHA) has specified the following permissible noise level exposures: According to OSHA, any exposure in excess of the above permissible limits could result in some hearing loss. Earplugs or protectors to the ear canals or over the ears must be worn when operating this amplification system in order to prevent a permanent hearing loss, if exposure is in excess of the limits as set forth above. To ensure against potentially dangerous exposure to high sound pressure levels, it is recommended that all persons exposed to equipment capable of producing high sound pressure levels such as this amplification system be protected by hearing protectors while this unit is in operation.

Duration Per Day in Hours	Sound Level dBA, slow response
8	90
6	92
4	95
3	97
2	100
1 ½	102
1	105
½	110
¼ or less	115

	<p>Intended to alert the user to the presence of uninsulated 'Dangerous Voltage' within the products enclosure that may be sufficient to constitute a risk of electrical shock to persons.</p> <p>Ce symbole est utilise pur indiquer a l'utilisateur de ce produit de tension non-isolee dangereuse pouvant etre d'intensite suffisante pour constituer un risque de choc electrique.</p> <p>Este simbolo tiene el proposito de alertar al usuario de la presencia de '(voltaje) peligroso' que no tiene aislamiento dentro de la caja del producto que puede tener una magnitud suficiente como para constituir riesgo de corrientazo.</p> <p>Dieses Symbol soll den Anwender vor unisolierten gefahrlichen Spannungen innerhalb des Gehauses warnen, die von Ausreichender Starke sind, um einen elektrischen Schlag verursachen zu konnen.</p>
	<p>Intended to alert the user of the presence of important operating and maintenance (Servicing) instructions in the literature accompanying the product.</p> <p>Dieses Symbol soll den Anwender vor unisolierten gefahrlichen Spannungen innerhalb des Gehauses warnen, die von Ausreichender Starke sind, um einen elektrischen Schlag verursachen zu konnen.</p> <p>Este simbolo tiene el proposito de la alertar al usuario de la presencis de instrucccones importantes sobre la operacion y mantenimiento en la literatura que viene conel producto.</p> <p>Dieses Symbol soll den Benutzer auf wichtige Instruktionen in der Bedienungsanleitung aufmerksam machen, die Handhabung und Wartung des Produkts betreffen.</p>
<p>CAUTION:</p> <p>ATTENTION:</p> <p>PRECAUCION:</p> <p>VORSICHT:</p>	<p>Risk of electrical shock - DO NOT OPEN. To reduce the risk of electrical shock, do not remove the cover. No user serviceable parts inside. Refer servicing to qualified personnel.</p> <p>Risques de choc electrique - NE PAS OUVIRIR Afin de reduire le risque de choc electrique, ne pas enlever le couvercle. Il ne se trouve a l'interieur aucune piece pouvant etre reparee par l'utilisateur. Confier l'entretien a un personnel qualifie.</p> <p>Riesgo de corrientazo - no abra Para disminuir el risego de corrientazo, no abra la cubierta. No hay piezas adentro que el pueda reparar. Deje todo mantenimiento a los tecnicos calificados.</p> <p>Risiko - Elektrischer Schlag! Nicht offen! Um das Risiko eines elektrischen Schlages zu vermeiden, nicht die Abdeckung entfernen. Es befinden sich keine Teile darin, die vom Anwender repariert werden Konnten. Reparaturen nur von qualifiziertem Fachpersonal durchfuhren lassen.</p>
<p>WARNING:</p> <p>ADVERTISSEMENT:</p> <p>ADVERTENCIA:</p> <p>ACHTUNG:</p>	<p>To prevent electrical shock or fire hazard, do not expose this appliance to rain or moisture. Before using this appliance please read the operating instructions for further warnings.</p> <p>Afin de prevenir les risques de decharge electrique ou de feu, n'exposez pas cet appareil a la pluie ou a l'humidite. Avant d'utiliser cet appareil, lisez les advertissments supplementaires situes dans le guide.</p> <p>Para evitar corrientazos o peligro de incendio, no deja expuesto a la lluvia o humedad este aparato Antes de usar este aparato, lea mas advrcticias en la guia de operacion.</p> <p>Um einen elektrischen Schalg oder Feuergefahr zu vermeiden, sollte dieses Gerat nicht dem Regen oder Feuchtigkeit ausgesetzt werden. Vor Inbetriebnahme unbedingt die Bedienungsanleitung lesen.</p>

FCC Compliancy Statement



This device complies with Part 15 of the FCC rules.

Operation is subject to the following two conditions:

- 1) This device may not cause harmful interference.
- 2) This device must accept any interference received, that may cause undesired operation.

Warning: Changes or modification to the equipment not approved by Laney can void the user's authority to use the equipment.

Note: This equipment has been tested and found to comply with the limits for Class B digital device, pursuant to Part 15 of the FCC Rules. These limits are designed to provide reasonable protection against harmful interference in a residential installation. This equipment generates, uses and can radiate radio frequency energy and if not installed and used in accordance with the instructions, may cause harmful interference to radio communications. However, there is no guarantee that interference will not occur in a particular installation. If this equipment does cause harmful interference to radio or television reception, which can be determined by turning the equipment off and on, the user is encouraged to try and correct the interference by one or more of the following measures.

Reorient or relocate the receiving antenna.

Increase the separation between the equipment and receiver.

Connect the equipment into an outlet on a circuit different from that to which the receiver is connected.

Consult the dealer or an experienced radio/TV technician for help.



This product conforms to the requirements of the following European Regulations, Directives & Rules:

CE Mark (93/68/EEC), Low Voltage (72/23/EEC), EMC (2004/108/EEC).

RoHS (EU2002/95/EC), WEEE (EU2002/96/EC).



In order to reduce environmental damage, at the end of its useful life, this product must not be disposed of along with normal household waste to landfill sites. It must be taken to an approved recycling centre according to the recommendations of the WEEE (Waste Electrical and Electronic Equipment) directive applicable in your country.

Windows is a registered trademark of Microsoft Corporation in the United States and other countries.

Mac, Mac OS & iPad are trademarks of Apple Inc., registered in the U.S. and other countries.

Android is a trademark of Google Inc.

Audacity is a trademark of Dominic Mazzoni.

MixPad Audio Mixer is a trademark of NCH Software, IncPro Tools is a trademark registered in the United States by Avid Technology, Inc.plc.

Controls - Front/Rear



1 2



3 4 5 6 7 8

1. RE-AMP: A feature that allows you to route a dry recorded signal through the IRT-PULSE. See page 14 for more information.

TIP RE-AMP enabled = INPUT disabled.
This switch has deliberately been recessed to prevent accidental activation.

2. INPUT: Connect your instrument here. Use only a high quality instrument cable.

3. PHONES Output and LEVEL: A 3.5mm stereo jack socket is provided. This can be used for headphones, a stereo feed to a recorder, amplifier, FX unit or PA system.

TIP Always set the headphone LEVEL to minimum before connecting headphones.

4. Line OUTPUT: A fully balanced (6.35mm jack) output for the maximum noise reduction. Use it to connect the IRT-PULSE to the next item in the signal chain - an amplifier, FX loop, FX unit or directly into a PA system.

TIP You can also connect an unbalanced instrument cable to the Line OUTPUT.

Controls - Rear continued

5. REMOTE: By connecting a Laney FS1 foot-switch (not included) you can switch the IRT-PULSE in and out of Bypass mode.

Note: for the foot-switch remote to function, the BYPASS switch on the IRT-PULSE has to be enabled.

6. AUX IN: This input allows for the connection of CD/MP3 player/iPOD (or any other line-level device) as a backing track. Ideal for a quiet jam session using headphones.

TIP — Control the level of the input using the volume control on your CD/MP3 player.

TIP — The AUX signal is routed to the PHONES OUTPUT only, not the Line OUTPUT.

7. POWER IN: Only connect the included DC PSU. Other types may cause damage to the IRT-PULSE!

TIP — It can take up to 30 seconds for the IRT-PULSE to be ready for use from a cold start.

TIP — Pulsing LED's = improper startup.
In the unlikely event this does occur, remove the power connector for 20 seconds before reconnecting.

8. USB I/O: Record replay connector, (Dry on left (1) channel, processed on right (2) channel). USB2.0 is compatible with Windows XP® operating system, Windows 7® operating system & Windows 8® operating system. Also compatible with Android, Mac® & iPad® 1-3 via camera USB adaptor, iPad® 4 & iPad Mini® via Lightning-USB camera adaptor cable. See page 14-16 for more information.

9: The bottom of the IRT-PULSE provides safety information and is where the serial number is situated.

Please make a note of the serial number in the space provided on the back cover of this user manual for future reference.



Controls - Top



10. DARK: Removes some of the HF content and allows for easier matching when connected to a bright amplifier input stage.

TIP — DARK only effects the Line OUTPUT.

11. BRIGHT: Provides an emphasis on the high frequency element of the signal. This effect is more obvious at lower gain settings.

12. HOT: When enabled, this function provides extra gain. HOT disabled and low GAIN setting - a progression from clean right through jazz/rock. HOT enabled and high GAIN settings - a full metal tone.

13. GAIN: Use to control the overdrive through the valve stages.

14. VOLUME: Controls the overall level. Experiment with GAIN/VOLUME combinations to achieve different sounds. Reducing the GAIN while increasing the VOLUME will result in a warm, open, over-driven sound. Reducing the VOLUME and increasing the GAIN will give a tighter modern sound with more distortion.

15. EQ: Add a pre-defined **IRT-Studio** EQ curve to the IRT-PULSE - bass lift, mid cut and a treble lift.

16. EMULATION: Adds a 4X12 speaker emulation to your signal. Enable this if you are going to connect directly to a PA system.

17. BYPASS: Routes the signal directly from INPUT to OUTPUT via a high impedance buffer, and switchable DARK function. The bypass can be operated remotely by connecting a foot-switch to the REMOTE socket.

Stand-Alone

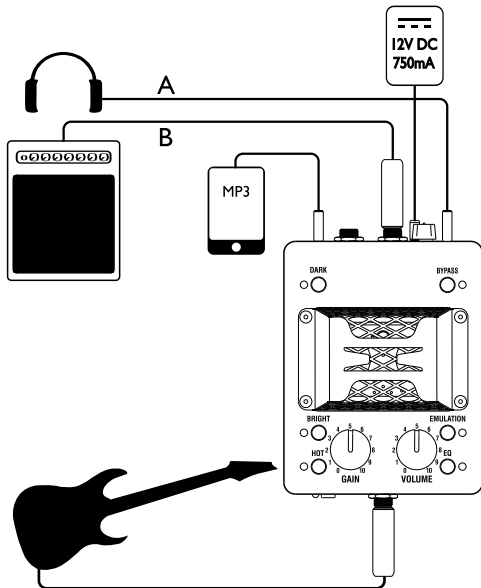

A: Use with headphones - initial setup:

All switches disabled.

LEVEL: 5.

GAIN: 5.

HEADPHONES Level: 0.

Slowly increase HEADPHONE level.

These settings will produce a mild over-drive.

TIP Give yourself a backing track by connecting an MP3 player/iPOD or any other line level device to the AUX input.

B: Use with an amplifier - initial setup:

All switches out.

Gain: 5.

Volume: 5.

Adjust the gain/volume settings on your amplifier to achieve the desired listening level.

FX-Loop

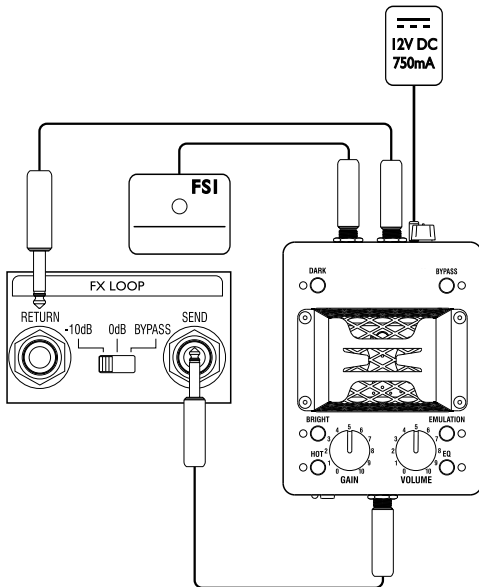

Add the IRT-PULSE to the insert loop of your amplifier or mixer.

This will help to provide further adjustment of gain/overdrive or to simply add a little valve warmth to a solid state amplifier or digitally processed signals.

FX-Chain

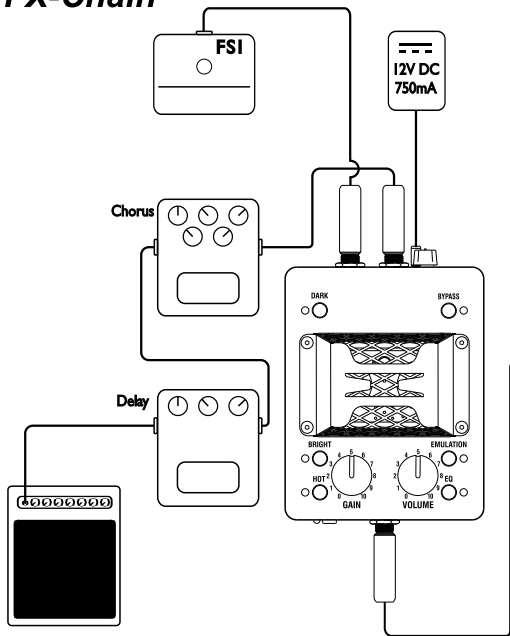

Another possibility is to add the IRT-PULSE into your FX-Chain.

Using a foot-switch (not included).

A Laney FSI single way foot-switch (or similar) is required to access the remote BYPASS function of your IRT-PULSE.

TIP The BYPASS switch on your IRT-PULSE must be activated to enable the remote bypass function.

Integration with your DAW

The IRT-PULSE comes into its own when used in conjunction with your DAW (digital audio workstation).

TIP See *USB and Re-Amping*: Pages 14-16.

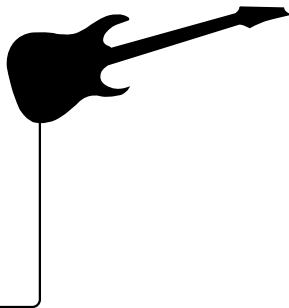
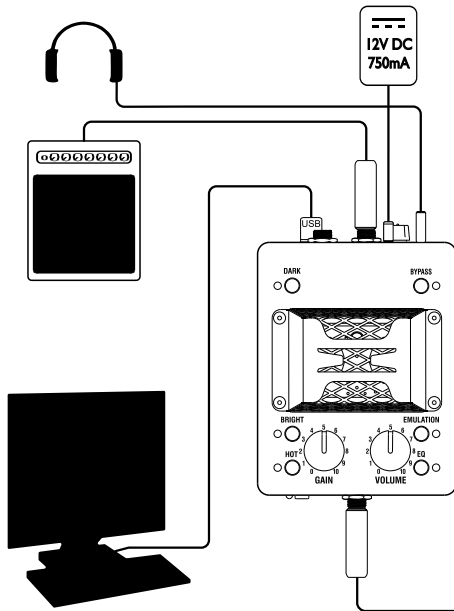

USB interface for PC, MAC, iPad and Android

USBs Interface options:

- USB2.0 Bidirectional to PC/Mac/iPad/Android etc.
- Simultaneously record dry guitar signal for later processing or Re-Amping.
- Re-Amp guitar track changing the settings as required.
- Add tube amplifier warmth to digital guitar tracks with or without speaker emulation.

Record out via USB.

To run into iPad or iPad mini connect via a Camera USB adaptor, PC/MAC connects via standard A-B USB cable, for use with the likes of Garage Band ®, Audacity ®, MixPad Audio Mixer ®, Pro Tools and similar. It should be noted that the audio output of an iPad or iPad mini is disengaged and returned via the USB.

Re-Amp Facility - A feature that allows you to route a dry recorded signal through your IRT-PULSE.

During recording, the IRT-PULSE processed signal is sent to the right channel (2). The left channel (1) carries the clean/unprocessed guitar signal.

TIP *In your digital recording software, copy the initial stereo track (dry left(1), processed right(2)) to two new tracks. This will give access to both raw and processed signals independently. Then Re-Amp the unprocessed to giving you two hand to experiment with the IRT-PULSE control surface.*

To Re-Amp via Garage Band on the iPad, solo the original channel and record a new one with RE-AMP activated on your IRT-PULSE. The newly processed signal will now appear on the right channel with unprocessed signal again on the left.

USB interface - Recording

Connect your USB recording device (PC/MAC/iPad/Android) via an appropriate USB cable. Your amplifier will send two audio tracks to your recording device:

(1) On the Left channel (1) is the direct unprocessed guitar signal.

TIP This can be used at a later date for “Re-Amping”.

(2) On the Right channel (2) is the fully processed signal.

These can be split into separate tracks in various ways dependent on your software. The processed signal sent to the right channel can be emulated or left untreated via the EMULATION switch.

TIP Alternatively record left & right as two separate tracks for maximum flexibility.

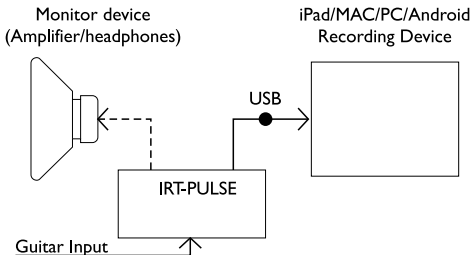

USB interface - Re-Amping

IRT-PULSE USB - RE-AMPING:

Connect your USB recording device (PC/MAC/iPad/Android) via an appropriate USB cable. Enable the RE-AMP switch on your IRT-PULSE. Output the original unprocessed guitar track by monitoring it on your record device.

TIP — For lowest noise performance, adjust the Dry signal send control for the maximum undistorted record level on your DAW.

Start your recording device. The monitored track will be sent to your IRT-PULSE via USB with the now processed signal being sent back to the recording device, again via USB. Use the controls on your IRT-PULSE to obtain the new sound you require.

You will now have the original track and the new re-processed version.

TIP — Make sure your monitor track output is being sent to the left channel (L) output or both.

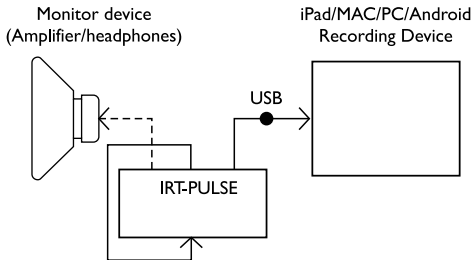

Signal Path Block diagram

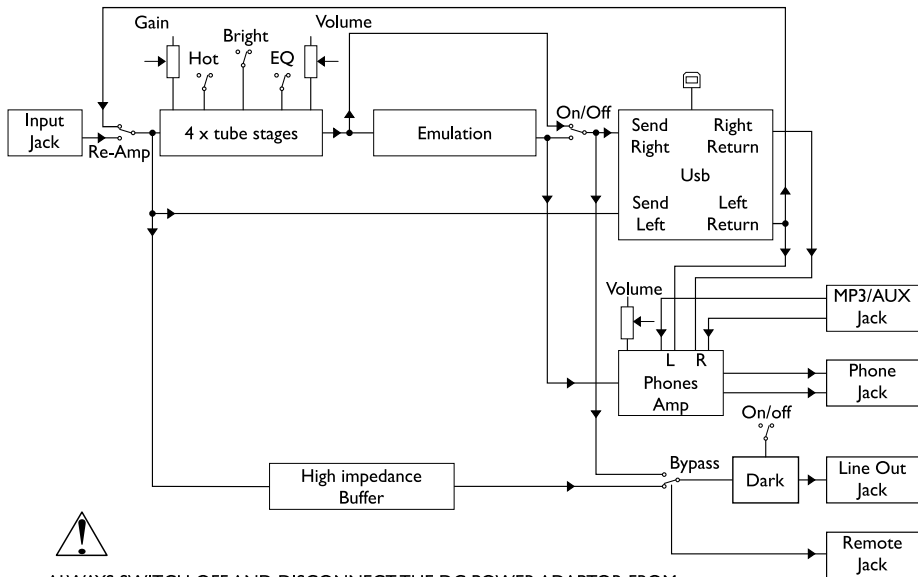

ALWAYS SWITCH OFF AND DISCONNECT THE DC POWER ADAPTOR FROM MAINS WHEN NOT IN USE.

Tube Care and Tips

Tube stages generally sound much warmer/sweeter than solid state transistor amplifiers but they also need a little more respect due to the fragile glass tubes. The IRT-PULSE uses a specially selected ECC83 High Voltage preamp tubes which should give you years of trouble free service, however like all tube amps; it is important to treat it with a certain amount of care. Use the following steps as a guide for how to take care of your IRT-PULSE :

Take care when moving your Pulse. Tubes are fragile glass components, and can easily be damaged if thrown in and out of vans.

Allow to warm up to room temperature before switching it on: the sudden thermal shock can crack a cold glass tube enclosure, plus any moisture is bad news around high voltage electronics.

Do not cover your IRT-PULSE during use. Tubes get warm.

After playing, allow to cool down before moving. Hot tubes are more fragile than cool ones.

A tubes life expectancy is based upon a number of factors which include operating temperature, how hard and how often it is played, vibration due to travel, etc. Tubes should be changed if you notice any deterioration in sound or performance. Otherwise, they need not be changed at any regular interval. Typical problems with preamp tubes include: crackly noise, hiss, hum, and microphony. If they fail or exhibit reduced performance, preamp tubes can simply be swapped out with no further action required.

The user should not attempt to service this product.

Method of replacing tubes for Qualified Service Engineers.

To change a tube, firstly unplug the 12VDC PSU and wait for the tubes to cool down. Remove the valve cage/cover. The tube can now be gently pulled out. Take care when inserting the new tube to make sure all pins are correctly aligned. Replace the top cover before connecting power.

Specifications

Operating voltage range:	~100V to ~240V 50-60Hz
Average power consumption:	6W
Input impedance:	1M ohms
Input sensitivity:	200uV
Aux input impedance:	3.3K
Output impedance:	470 ohms
USB:	44.1kHz Standard Slave CODEC PC/MAC/iPad/Android compatible
Unit dimensions/mm:	Actual: - H80LxW95xD120 / Boxed: H90LxW110xD220
Weight:	Actual 520g / Boxed 900g
Carton contents:	IRT-PULSE / 12VDC Power supply / clip on plug adaptor Draw-string carry bag / User manual
Optional extras:	Laney FSI- Single way foot-switch

Please retain your original carton and packaging so in the unlikely event that some time in the future your product should require servicing you will be able to return it to your dealer securely packed.

Care of your Laney amplifier will prolong it's life.....and yours!

In the interest of continued development, Laney reserves the right to amend product specification without prior notification.

Model number:

Serial number:

Place of purchase:

Date of purchase:

Please complete for future reference.



www.laney.co.uk

